

UN Certification: 3H2/Y25/S 

Cover Specification | Part No. 600646

Origin of Materials	100% US Manufactured
Material	High Density Polyethylene (HDPE)
Mfg. Method	Injection Molding
Weight	.98 lbs / 443 g
Height	1.86"
Min Wall Thickness	.120"
Standard Color	White <i>Please inquire about custom colors</i>
Quantity	64 per Case 512 per Pallet

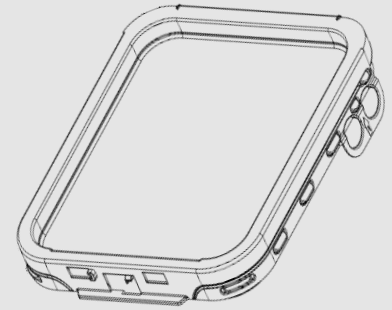

Pail Specification | Part No. 500410

Origin of Materials	100% US Manufactured
Material	High Density Polyethylene (HDPE) <i>Plastic Handle</i>
Mfg. Method	Injection Molding
Weight	2.99 lbs / 1358 g
Min. Wall Thickness	.090"
Exterior Height	14.53" With Cover 14.75"
Top Inside Diameter	9.18" / 11.01"
Bottom Outside Diameter	8.76 / 10.50"
Shipping Quantity	80 Units per Pallet 3,680 Units per Truckload
Standard Color	White <i>Please inquire about custom colors</i>
Print Area	Contact Customer Service
Decoration	In Mold Labeling (IML)
Top Load Rating	275 lbs

