

UN Certification: 1H2/Y30/S & 1H2/Y1.5/30 

Cover Specification | Spouted 600238 | Nonspouted 600237

Origin of Materials	100% US Manufactured
Material	High Density Polyethylene (HDPE)
Mfg. Method	Injection Molding
Weight	1.57 lbs / 614g
Height	2"
Min Wall Thickness	.090"
Outside Diameter	Top 12.47" Bottom 13.07"
Fitting	Nonspouted American Flange Plastic 38mm Spout
Standard Color	White, Red 186, Blue 300 <i>Please inquire about custom colors</i>
Case Quantity	20 per case / 240 per pallet

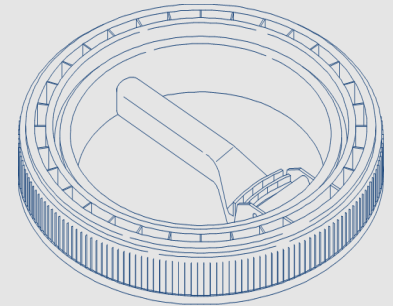

Pail Specification | Part 500109

Origin of Materials	100% US Manufactured
Material	High Density Polyethylene (HDPE)
Mfg. Method	Injection Molding / Plastic Handle
Weight	2.83 lbs / 1191 g
Min. Wall Thickness	.090"
Exterior Height	16.46" With Cover 16.75"
Top Inside Diameter	12.03"
Gasket	Gasket Neoprene (EPDM)
Bottom Outside Diameter	10.51"
Shipping Quantity	3 Pails and Covers Per Case 72 Units per Pallet 2,880 Units per Truckload
Standard Color	White <i>Please inquire about custom colors</i>
Print Area	9" x 34.25"
Top Load Rating	425 lbs

