

<b>Cover Specification</b>	
Origin of Materials	100% US Manufactured
Material	Polyethylene
Mfg. Method	Injection Molding
Weight	3/8 lb / 157 g
Height	1 7/8"
Bottom Outside Diameter	9 5/8" x 9 5/8"
Top Outside Diameter	9 7/8" x 9 7/8"
Min Wall Thickness	.060"
Standard Color	White <i>Please inquire about custom colors</i>
Quantity	<b>1200 Units per Pallet</b> (if pails have no middle pallet Double Stacked, 10,800 Units per Truckload) <b>1265 Units per Pallet</b> (if pails have a middle pallet Double Stacked, 10,120 Units per Truckload)

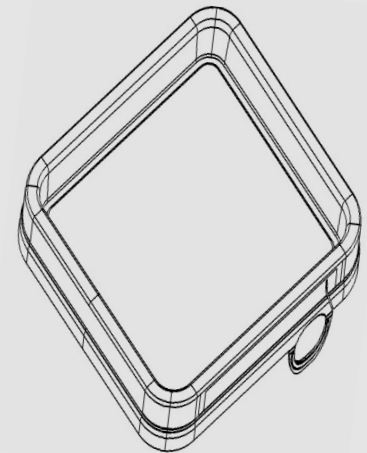

<b>Pail Specification</b>	
Origin of Materials	100% US Manufactured
Material	Polypropylene
Mfg. Method	Injection Molding
Weight	1 1/8 lbs. / 525grams
Min. Wall Thickness	.065"
Exterior Height	14 5/8" With Cover 14 3/4"
Top Inside Diameter	9 1/8" x 9 1/8"
Bottom Outside Diameter	8 3/8" x 8 3/8"
Shipping Quantity	<b>240 Units per Pallet</b> (No Middle Pallet Double Stacked) 10,800 Units per Truckload <b>220 Units per Pallet</b> (With Middle Pallet Double Stacked) 10,120 Units per Truckload
Standard Color	White <i>Please inquire about custom colors</i>
Decoration	In Mold Labeling (IML)
Top Load Rating	300 lbs.

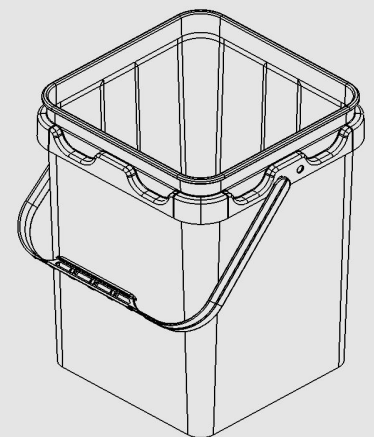

**Pack Specifications For Cover**

**Shipped with Double Stacked**

**Pallets, No Middle Pallet**

- 1200 lids per pallet
- 20 Stacks x 60 high
- Lid Material is PP

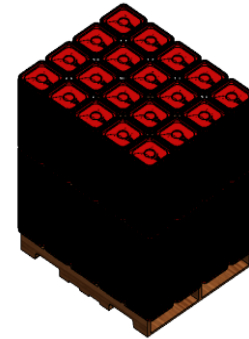
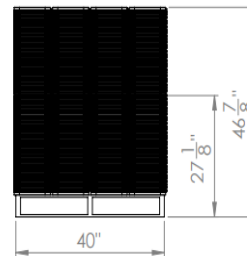
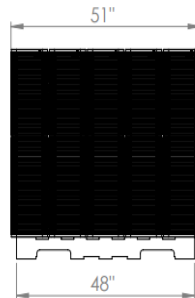
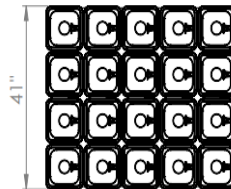

**Pack Specifications For**  
**Cover Shipped with**  
**Double Stacked Pallets,**  
**With Middle Pallet**

- 1265 lids per pallet
- 20 Stacks x 63 high
- Lid Material is PP

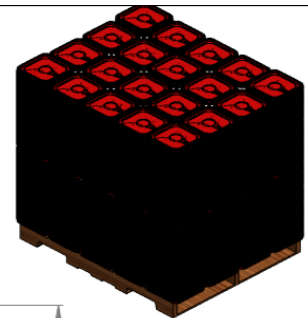
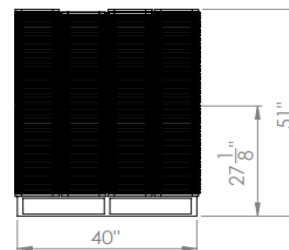
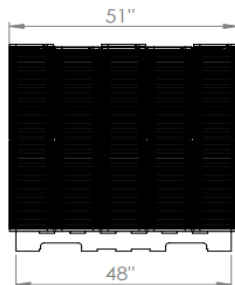
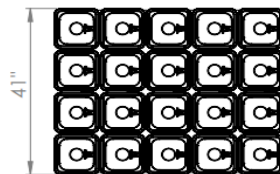

**Pack Specifications For Pail**

**Shipped with Double Stacked**

**Pallets, No Middle Pallet**

- 240 pails per pallet
- 20 Stacks x 12 high
- Pail Material is PP

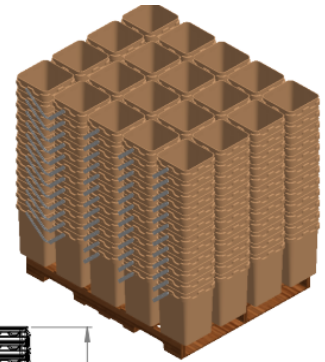
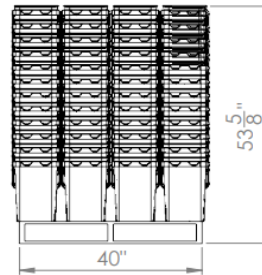
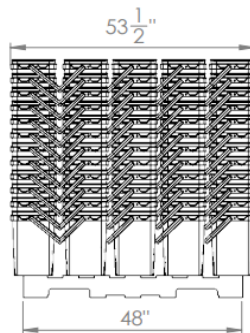
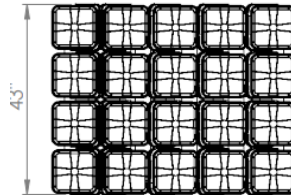

**Pack Specifications For Pail Shipped with Double Stacked Pallets, With Middle Pallet**

- 220 pails per pallet
- 20 Stacks x 11 high
- Pail Material is PP

